

Speaker

Model: OSS37-57-27A4.0W8



ELECTRICAL SPECIFICATIONS

	Condition	Parameter	Unit
Sound Pressure Level	at 0.1W, 0.1M [at 0.6, 0.8, 1.0, 1.2KHz]	97 ± 3	dB
Impedance	at 1V, 1000Hz	8 ± 15%	Ω
Rated Input Power		4	W
Max Input Power		5	W
Resonant Frequency (Fo)	at 1V	1100 ± 20%	Hz
Frequency Range		F0 ~ 15000	Hz
Buzzer & Rattles	not be audible at sine wave between F0 ~ 15KHz	5.65	V
Operating Temperature		-30 ~ 60	°C
Magnet		Ferrite	
Frame Material		Metal	
Cone Material		Mylar (PET)	
Weight		98	g

MECHANICAL DRAWING

Dimensions in mm

Tolerance ±0.5mm Except Specified

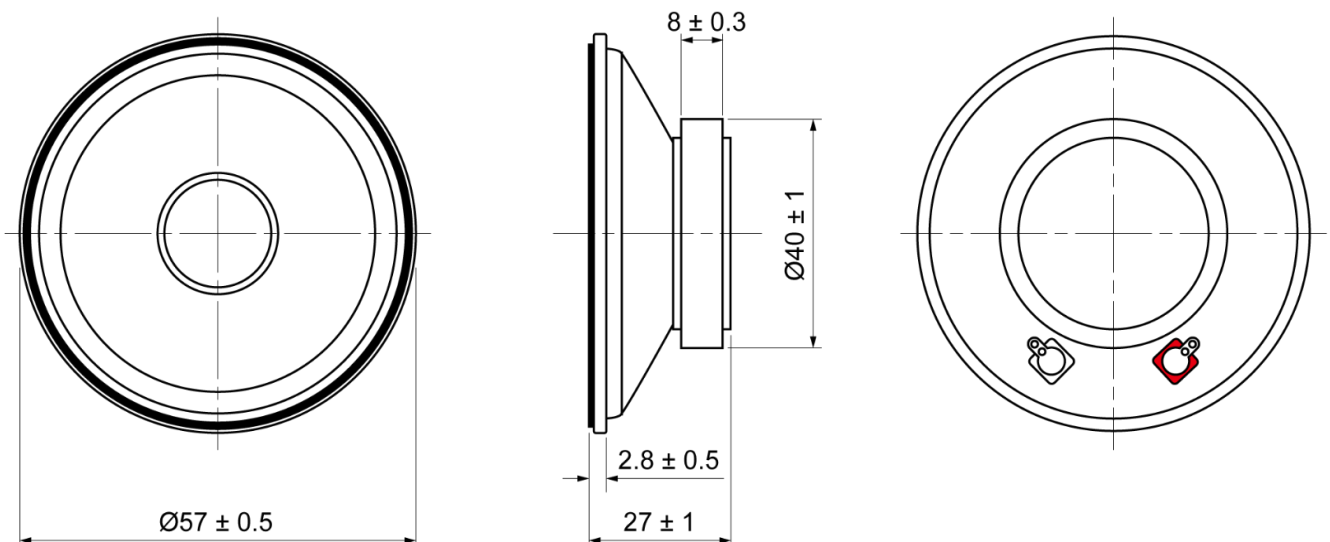

Speaker

Model: OSS37-57-27A4.0W8

FREQUENCY RESPONSE CURVE

